

Cylinder 6 stage front end with spherical eye

CD19TS6004895NA10992

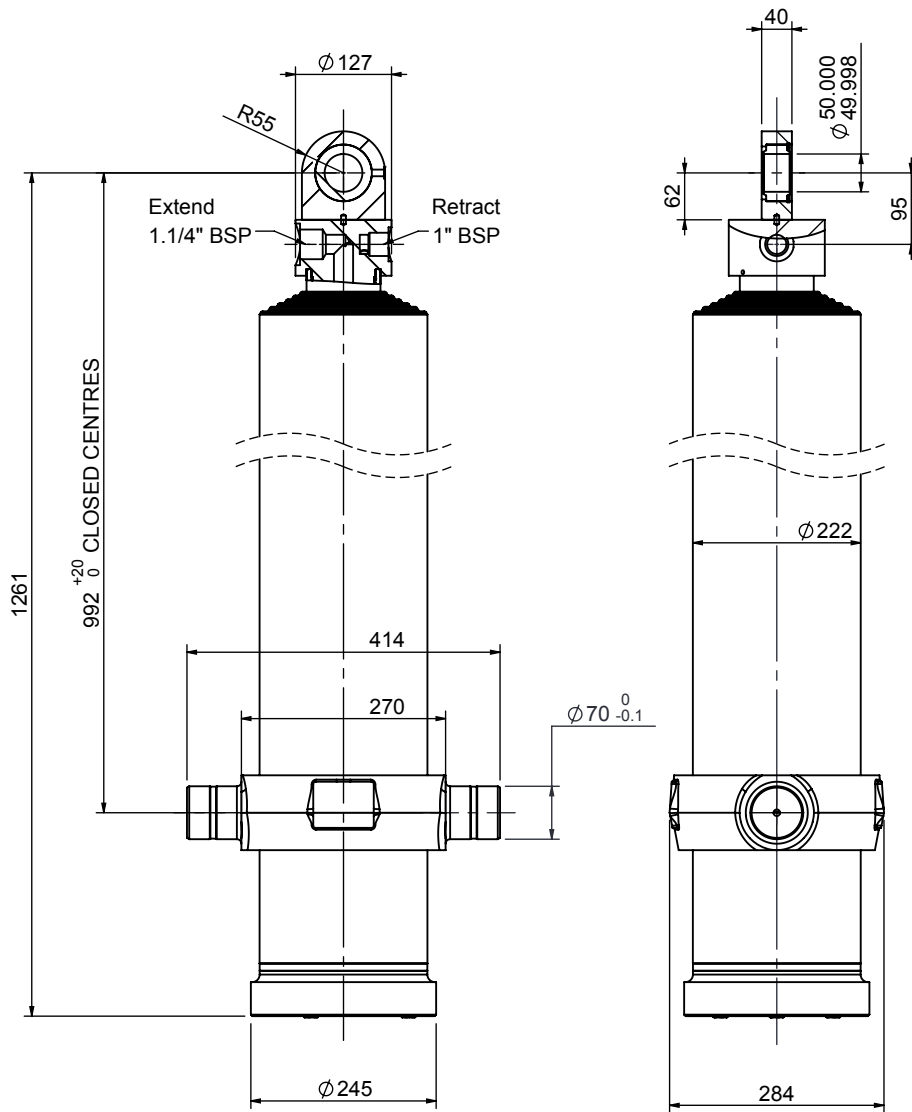

SPECIFICATION

Stage	Tube Diameter	Tube Bore	Length	Stroke	Swept Volume (Extend)	Swept Volume (Retract)
Base	222	206	1078	-	-	-
1	198	184	1039	790	26.3	2.0
2	176	163	1039	800	21.3	1.8
3	155	144	1039	810	16.9	1.6
4	136	125	1039	820	13.4	1.4
5	116	106	1039	835	10.2	1.4
6	98	87	1064	840	7.4	1.1
Total (+5/-10)				4895	mm	
Final stroke reduced by				0	mm	
Swept Vol (Extend)				95.5	Litres	
Swept Vol (Retract)				9.3	Litres	
Maximum Pressure				190	Bar	
Operating Pressure				190	Bar	
Cylinder Mass				229	Kg	
Stage	Thrust @ Max.Press		Thrust @ Op. Press			
	Extend	Retract	Extend	Retract		
1	64.6	4.9	64.6	4.9		
2	51.5	4.4	51.5	4.4		
3	40.4	3.9	40.4	3.9		
4	31.5	3.4	31.5	3.4		
5	23.8	3.3	23.8	3.3		
6	17.1	2.5	17.1	2.5		

INNER TUBES HARD CHROMED



JOST UK Ltd
 Edbro House, Nelson Street, Bolton, England, BL3 2JJ
 Tel +44 (0) 1204 528888 Fax +44 (0) 1204 531957
 Email: sales@jost-world.com Web: www.edbro.com

Technical Specifications are subject to change without notice
 Date Created/Updated: 08 October 2018
 Refer www.edbro.com to confirm latest specification
 All dimensions are in 'mm', unless otherwise stated

