

Cylinder 6 stage front end with spherical eye

CD19TS611501BD11295

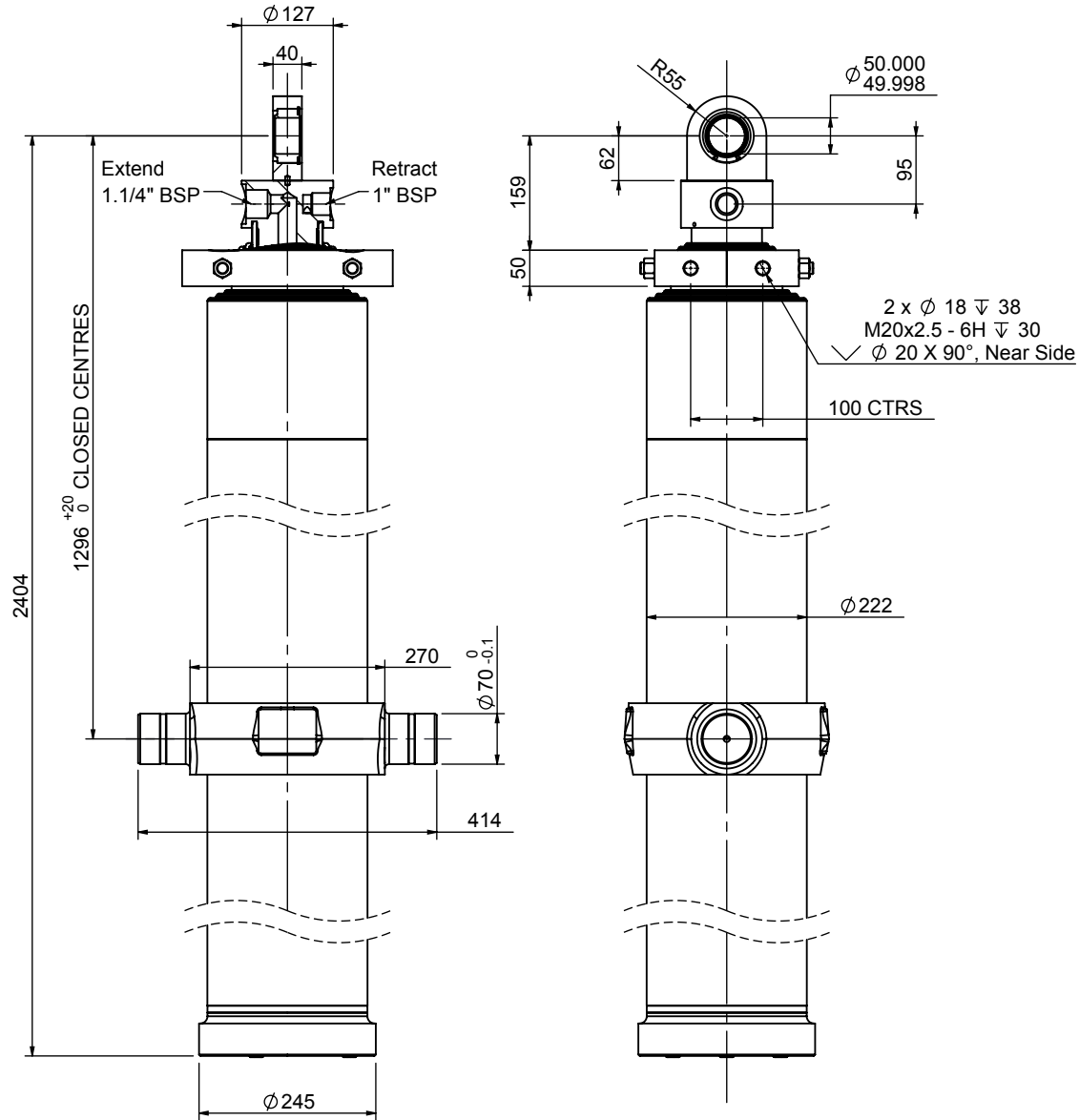

SPECIFICATION

Stage	Tube Diameter	Tube Bore	Length	Stroke	Swept Volume (Extend)	Swept Volume (Retract)
Base	222	206	2179	-	-	-
1	198	184	2140	1891	63.0	4.8
2	176	163	2140	1901	50.6	4.3
3	155	144	2190	1911	39.9	3.8
4	136	125	2190	1971	32.1	3.5
5	116	106	2190	1986	24.4	3.4
6	98	87	2215	1841	16.2	2.4
Total (+5/-10)				11501	mm	
Final stroke reduced by				150	mm	
Swept Vol (Extend)				226.2	Litres	
Swept Vol (Retract)				22.2	Litres	
Maximum Pressure				190	Bar	
Operating Pressure				190	Bar	
Cylinder Mass				429	Kg	
Stage	Thrust (t)					
	Extend	Retract				
1	51.5	4.4				
2	40.4	3.9				
3	31.5	3.4				
4	23.8	3.3				
5	17.1	2.5				
6	11.5	11.5				

INNER TUBES HARD CHROMED



Edbro plc
 Nelson Street, Bolton, England, BL3 2JJ
 Tel +44 (0) 1204 528888 Fax +44 (0) 1204 531957
 Email: postmaster@edbro.com Web: www.edbro.com

Technical Specifications are subject to change without notice
 Date Created/Updated: 24 July 2018
 Refer www.edbro.com to confirm latest specification
 All dimensions are in 'mm', unless otherwise stated

