

Cylinder 4 stage front end with plain eye

CS130E43841B19A01

SPECIFICATION

TIPPING CAPACITY : 25-40 TONNES***

Stage	Diameter	Length	Stroke	Swept Volume
-	-	-	-	-
-	-	-	-	-
0	155	1175	-	-
1	136	1140	938	14
2	117	1140	962	10
3	98	1140	967	7
4	79	1140	972	5
Total (+5/-10)			3839	36
Final stroke reduced by	0	Priming Volume		10
Cylinder Mass (Kg)	106	Total Volume (Litres)		45
Maximum Pressure (Bar)	190	Max. first stage thrust		200 KN

*****TIPPING CAPACITY AT WORKING PRESSURE**

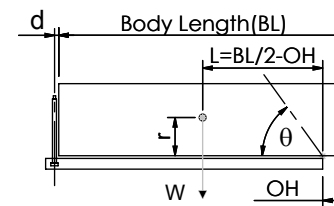

BODY LENGTH (BL)						OH
5100	5300	5500				
27	47°	26	45°	25	43°	150
32	50°	30	48°	28	46°	450
40	54°	37	51°	34	49°	750

d = 0; r = 750; Working Pressure 175 bar

For guidance only;

Higher working pressures and tipping capacities may be possible.

To check your application email - applications@edbro.co.uk

NOTES

1. This cylinder is for lifting purposes only and side load conditions should be avoided
2. Cylinder is painted in primer paint to RAL5013
3. Refer to www.edbro.com for:-
 - Bracket details
 - Installation instructions that must be observed
 - Correct oil selection
 - An explanation of tipping capacity

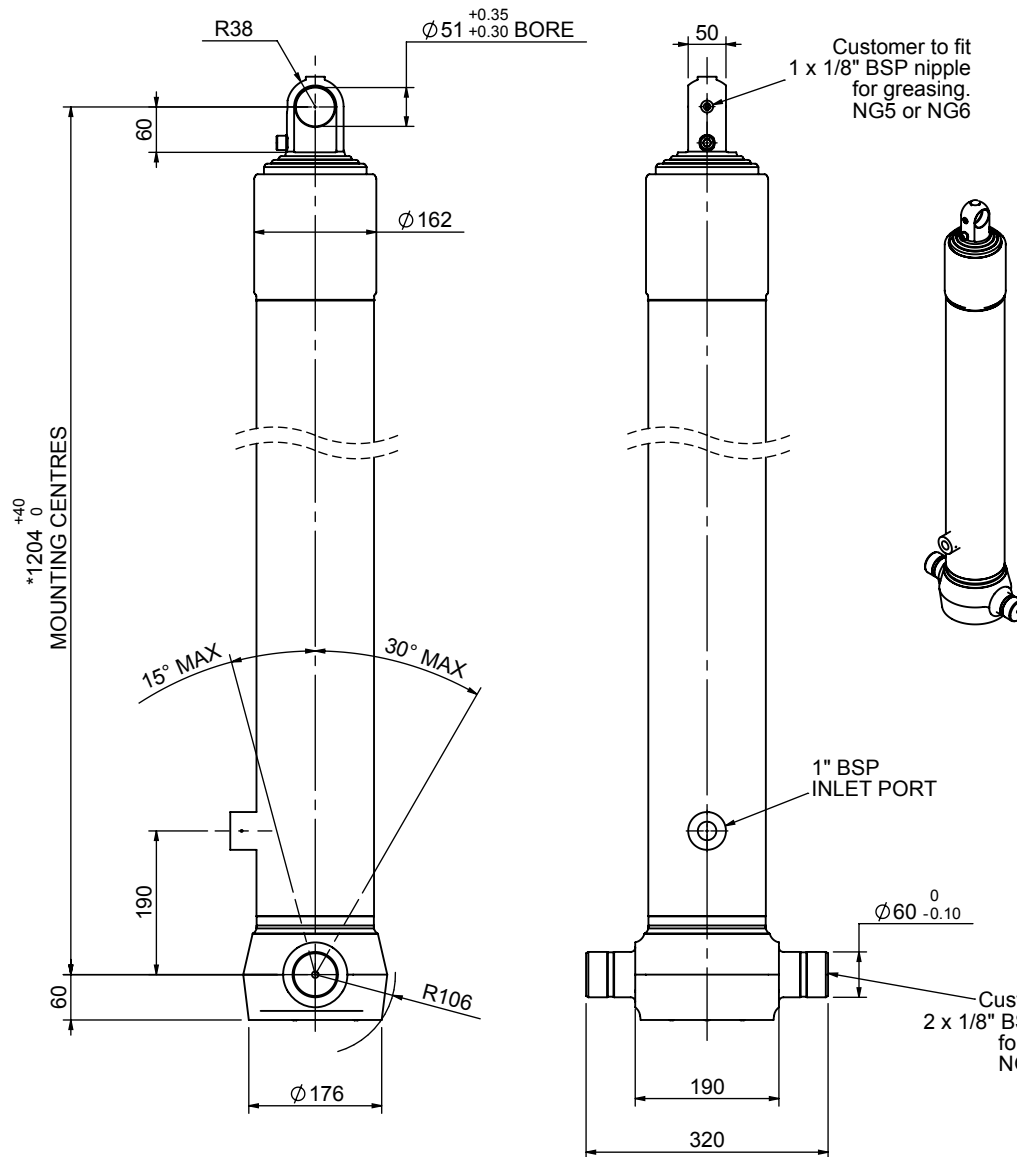

*Includes 9mm Pull Out.
Last Stage Chrome Plated



Edbro plc
Nelson Street, Bolton, England, BL3 2JJ
Tel +44 (0) 1204 528888 Fax +44 (0) 1204 531957
Email: postmaster@edbro.com Web: www.edbro.com

Technical Specifications are subject to change without notice
Date Created/Updated: 10 September 2012
Refer www.edbro.com to confirm latest specification
All dimensions are in 'mm', unless otherwise stated

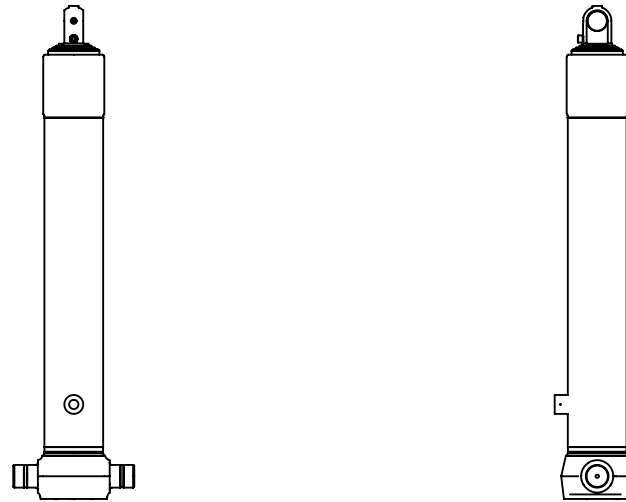

CS130E43841B19A01