

Cylinder 5 stage front end with outer cover

****ALLOW 50mm TO REMOVE CAP FOR SERVICING**

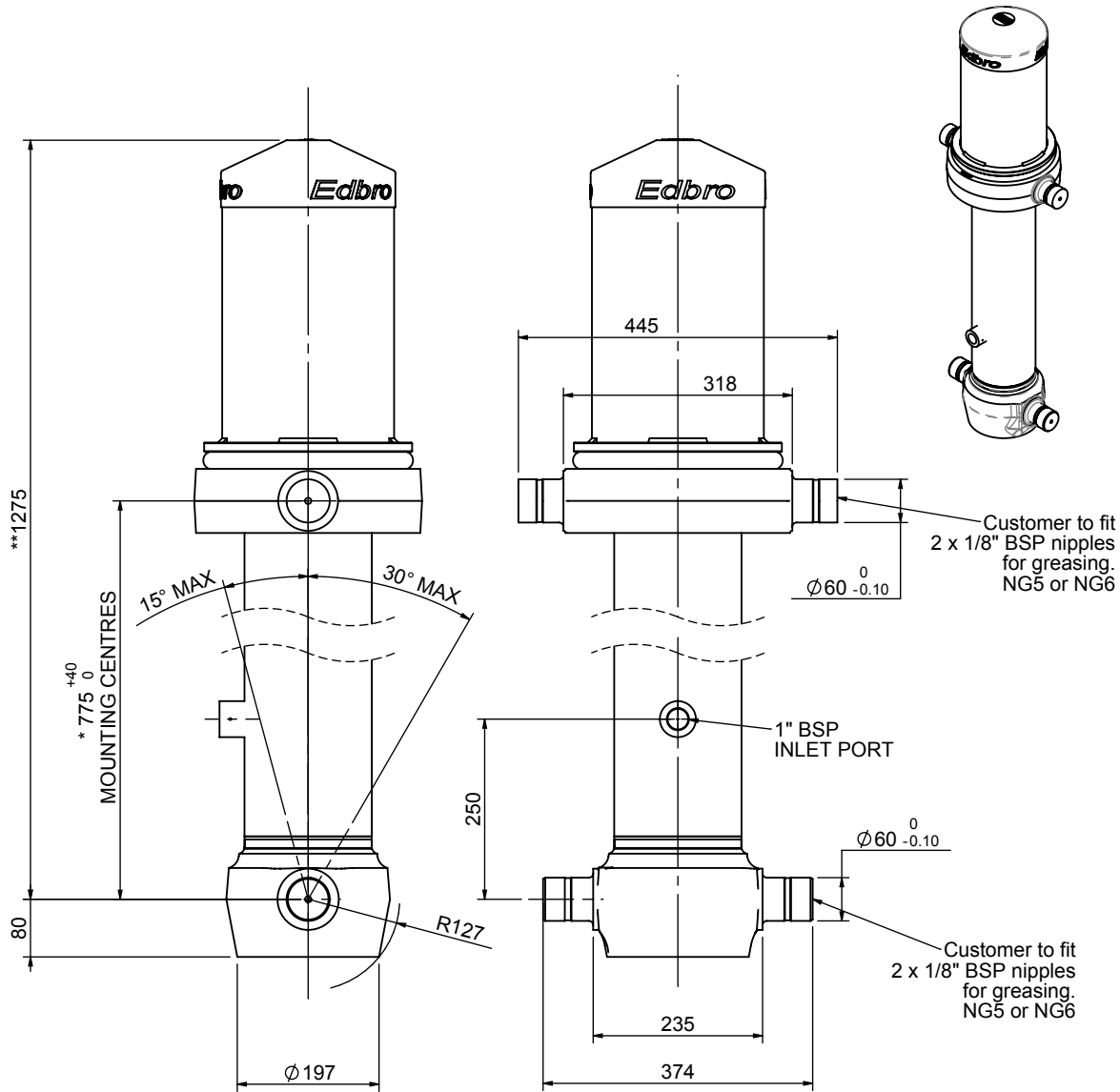

*Includes 11mm Pull Out.

CS150055027B25A13

SPECIFICATION		TIPPING CAPACITY : 26-38 TONNES***		
Stage	Diameter	Length	Stroke	Swept Volume
OUTER COVER	239	465	-	-
0	177	1225	-	-
1	155	1190	975	18
2	136	1190	997	14
3	117	1190	1012	11
4	98	1190	1017	8
5	79	1190	1022	5
Total (+5/-10)			5023	56
Final stroke reduced by	0	Priming Volume		12
Cylinder Mass (Kg)	199	Total Volume (Litres)		68
Maximum Pressure (Bar)	190	Max. first stage thrust		225 KN

***TIPPING CAPACITY AT WORKING PRESSURE

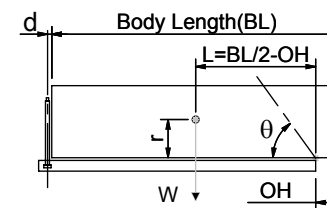

		BODY LENGTH (BL)				OH
		6250	6500	6750		
28	47°	27	45°	26	44°	150
32	50°	30	47°	29	46°	450
38	53°	35	50°	33	48°	750

d = 229; r = 750; Working Pressure 175 bar

For guidance only;

Higher working pressures and tipping capacities may be possible.

To check your application email - applications@edbro.co.uk

NOTES

1. This cylinder is for lifting purposes only and side load conditions should be avoided
2. Cylinder is painted in primer paint to RAL5013
3. Refer to www.edbro.com for:-
 - Bracket details
 - Installation instructions that must be observed
 - Correct oil selection
 - An explanation of tipping capacity

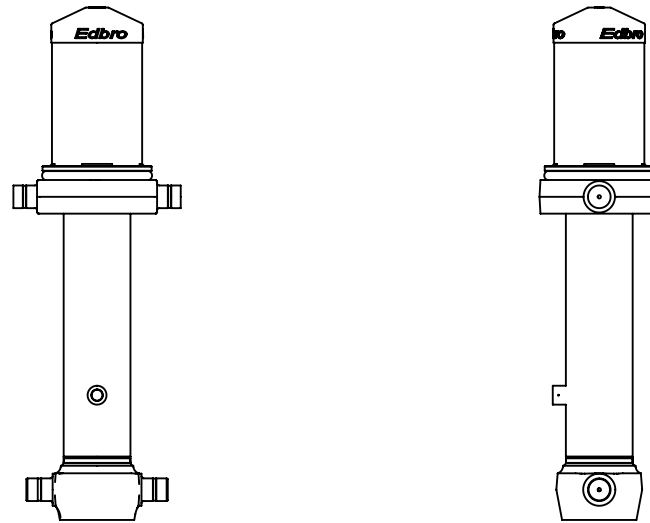

CS150055027B25A13