

Cylinder 5 stage front end with Outer Cover

****ALLOW 50mm TO REMOVE CAP FOR SERVICING**

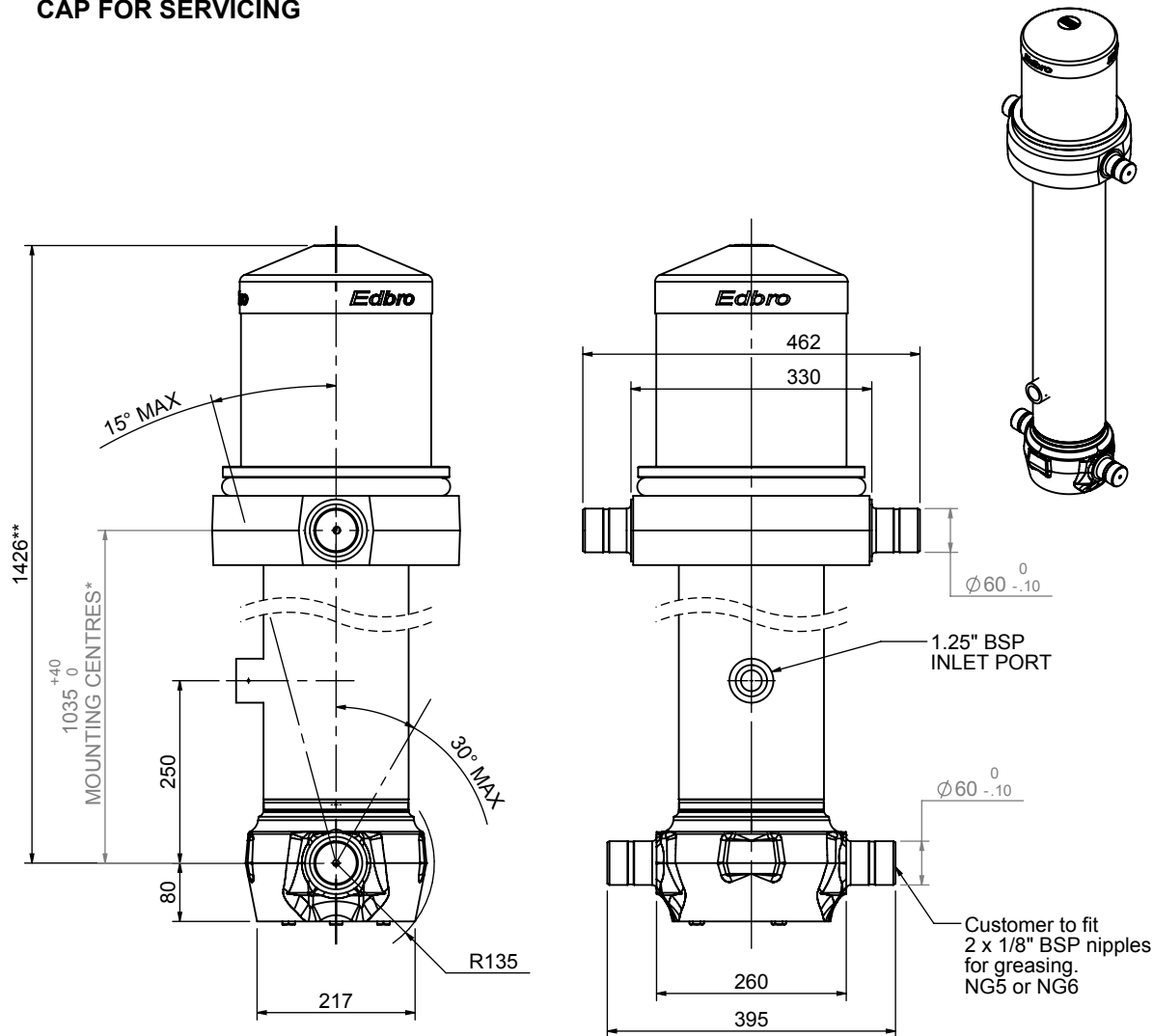

CS170055733B25A15

SPECIFICATION		RATED CAPACITY : 38-57 TONNES***		
Stage	Diameter	Length	Stroke	Swept Volume
OUTER COVER	261	355	-	-
0	199	1375	-	-
1	176	1340	1114	27
2	155	1340	1137	21
3	136	1340	1147	17
4	117	1340	1162	12
5	98	1340	1167	9
Final stroke reduced by	0	Total (+5/-10)	5727	86
Cylinder Mass (Kg)	260.19	Priming Volume	18	
Rated Pressure (Bar)	175	Total Volume (Litres)	104	
Maximum Pressure (Bar)	175	Max. first stage thrust	260 KN	

***TIPPING CAPACITY AT RATED PRESSURE

d = 229 ; r = 900

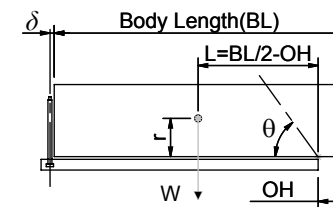

BODY LENGTH (BL)					OH	
7000		7500		8000		
43	48°	40	45°	38	42°	150
49	51°	44	47°	41	44°	450
57	53°	50	49°	46	46°	750

Tipping angle (θ)
 Body + payload mass, W (tonne)

For guidance only;

Higher Rated Pressures may be possible. To check your application, email Edbro plc at <applications@edbro.co.uk>

NOTES

- If hydraulic pressure is used to limit overloading, the system relief valve must be set to the Rated Pressure unless agreed otherwise by Edbro
- The system relief valve can be set to Maximum Pressure if the load is limited by other means. See RATINGS page for advice
- This cylinder is for lifting purposes only and sload conditions must be avoided
- Cylinder is painted in primer paint to RAL5013
- See bracket options page BRKT01, BRKT02
- See installation instructions INSTALL01
- Use oil according to specification OIL01

*Includes 12mm Pull Out

Edbro
SETTING THE INDUSTRY STANDARD

Edbro plc
Nelson Street, Bolton, Lancashire BL3 2JJ UK
Tel +44 (0) 1204 528888 Fax +44 (0) 1204 531957
Email: postmaster@edbro.com Web: www.edbro.com

Technical Specifications are subject to change without notice
Date Created/Updated: 21 August 2009 15:38:03
Refer www.edbro.com to confirm latest specification
All dimensions are in 'mm', unless otherwise stated