

Cylinder 5 stage front end with outer cover

****ALLOW 50mm TO REMOVE CAP FOR SERVICING**

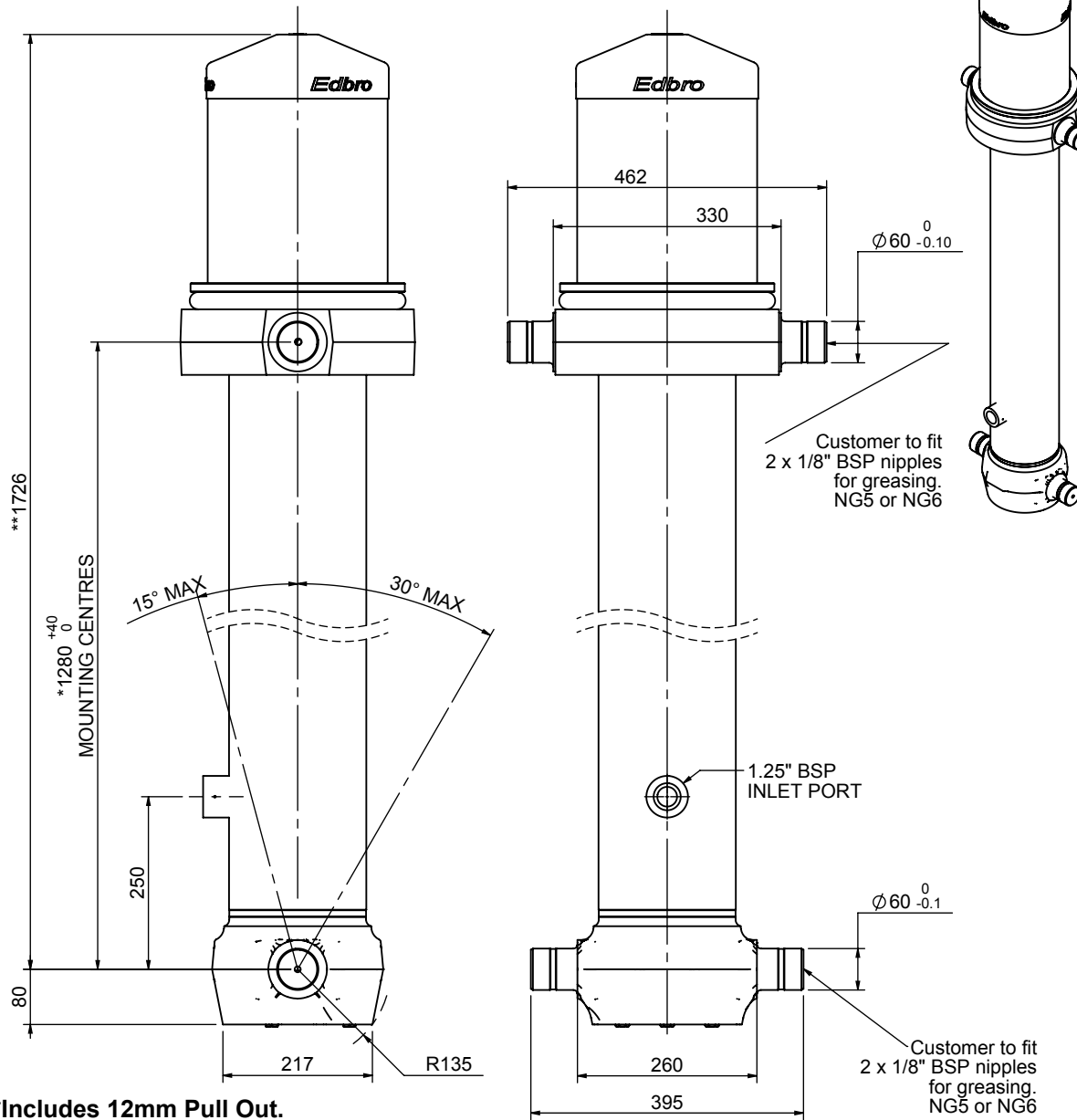

*Includes 12mm Pull Out.

CS170057233B25A17

SPECIFICATION		TIPPING CAPACITY : 28-37 TONNES***		
Stage	Diameter	Length	Stroke	Swept Volume
OUTER COVER	261	410	-	-
0	199	1675	-	-
1	176	1640	1414	34
2	155	1640	1437	27
3	136	1640	1447	21
4	117	1640	1462	16
5	98	1640	1467	11
Total (+5/-10)			7227	109
Final stroke reduced by	0	Priming Volume		22
Cylinder Mass (Kg)	294	Total Volume (Litres)		131
Maximum Pressure (Bar)	190	Max. first stage thrust		265 KN

***TIPPING CAPACITY AT WORKING PRESSURE

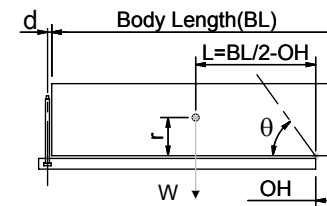

BODY LENGTH (BL)						OH
8750	9250	9750				
30	49°	29	46°	28	44°	150
33	51°	31	48°	29	45°	450
37	53°	34	50°	32	47°	750

d = 229; r = 900; Working Pressure 130 bar

Tipping angle (θ)

Body + payload mass, W (tonne)

For guidance only;

Higher working pressures and tipping capacities may be possible.

To check your application email - applications@edbro.co.uk

NOTES

1. This cylinder is for lifting purposes only and side load conditions should be avoided
2. Cylinder is painted in primer paint to RAL5013
3. Refer to www.edbro.com for:-
 - Bracket details
 - Installation instructions that must be observed
 - Correct oil selection
 - An explanation of tipping capacity

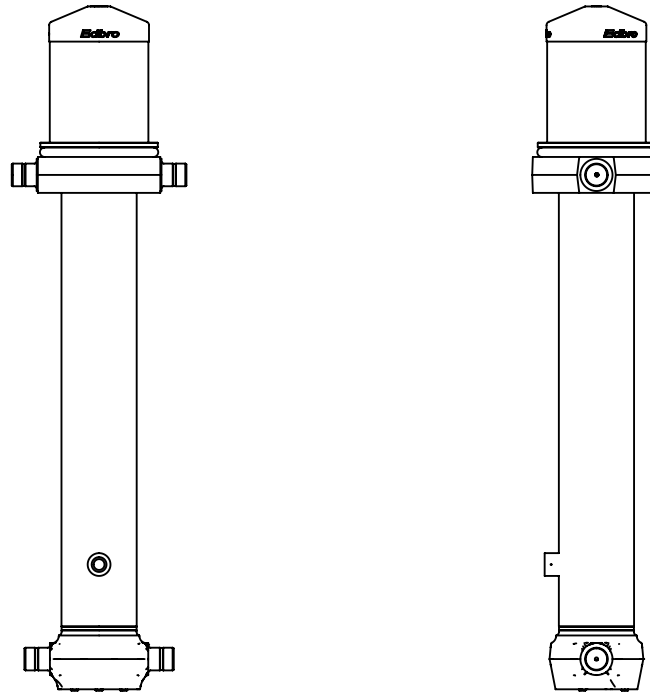

CS170057233B25A17