

Cylinder 5 stage front end with outer cover

****ALLOW 50mm TO REMOVE CAP FOR SERVICING**

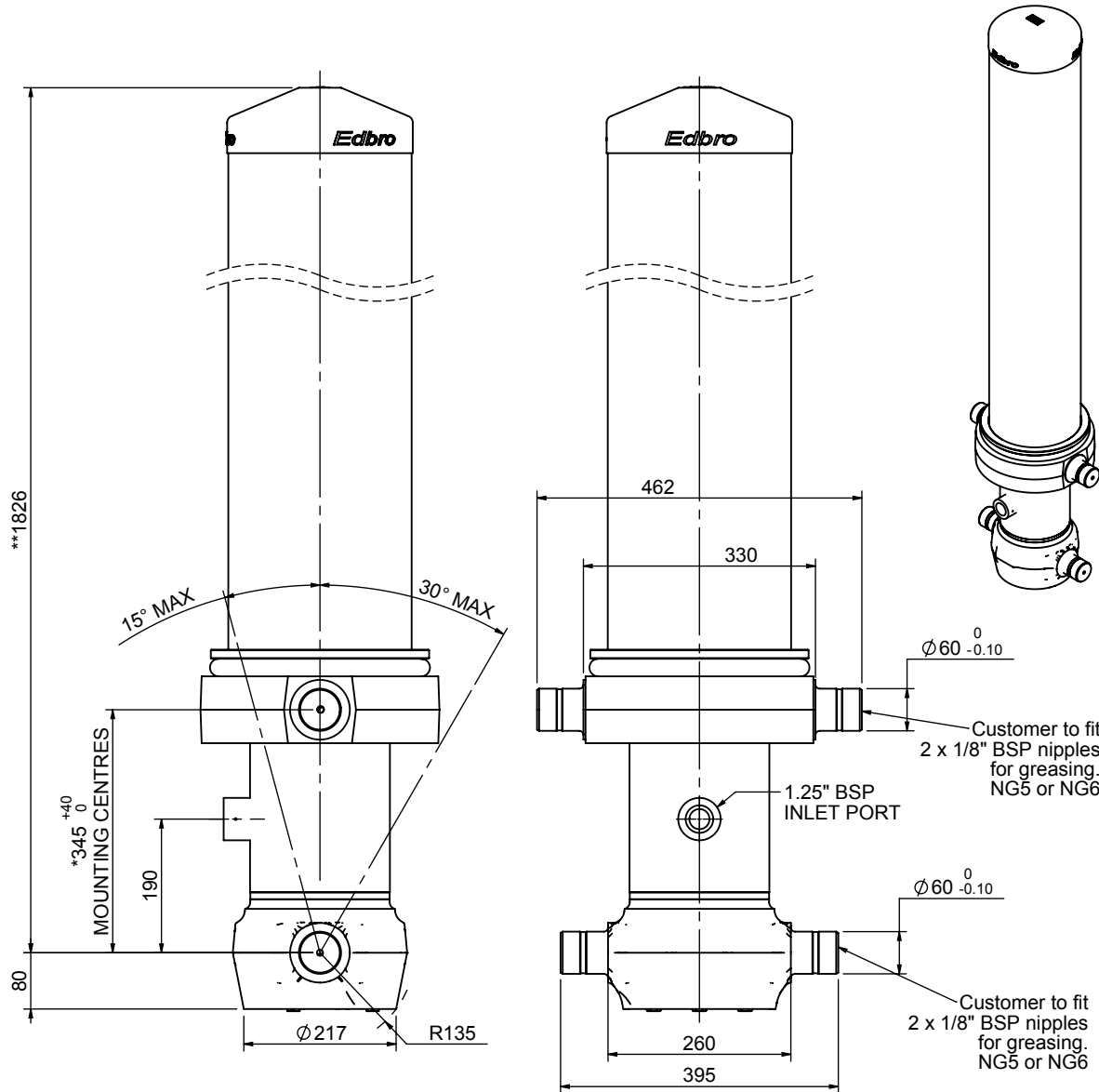

*Includes 12mm Pull Out.

CS170057733B19A11

SPECIFICATION		TIPPING CAPACITY : 38-51 TONNES***		
Stage	Diameter	Length	Stroke	Swept Volume
OUTER COVER	261	1445	-	-
0	199	1775	-	-
1	176	1740	1514	37
2	155	1740	1537	29
3	136	1740	1547	22
4	117	1740	1562	17
5	98	1740	1567	12
Total (+5/-10)			7727	117
Final stroke reduced by	0	Priming Volume		24
Cylinder Mass (Kg)	336	Total Volume (Litres)		141
Maximum Pressure (Bar)	190	Max. first stage thrust		265 KN

***TIPPING CAPACITY AT WORKING PRESSURE

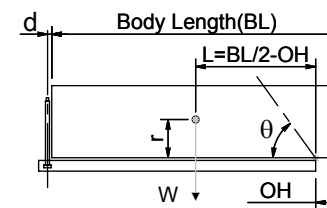

BODY LENGTH (BL)						OH
9000	9500	10000				
42	51°	40	48°	38	45°	150
46	53°	43	49°	41	47°	450
51	55°	47	51°	44	48°	750

d = 229; r = 900; Working Pressure 175 bar

For guidance only;

Higher working pressures and tipping capacities may be possible.

To check your application email - applications@edbro.co.uk

NOTES

1. This cylinder is for lifting purposes only and side load conditions should be avoided
2. Cylinder is painted in primer paint to RAL5013
3. Refer to www.edbro.com for:-
 - Bracket details
 - Installation instructions that must be observed
 - Correct oil selection
 - An explanation of tipping capacity

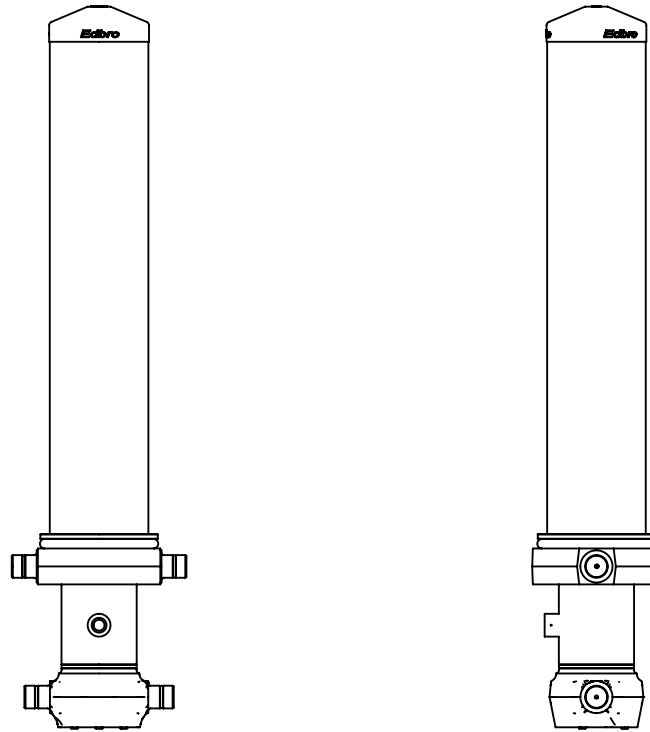

CS170057733B19A11