

Cylinder 5 stage front end with Outer Cover

NOTE: ALLOW 50mm TO REMOVE CAP FOR SERVICING

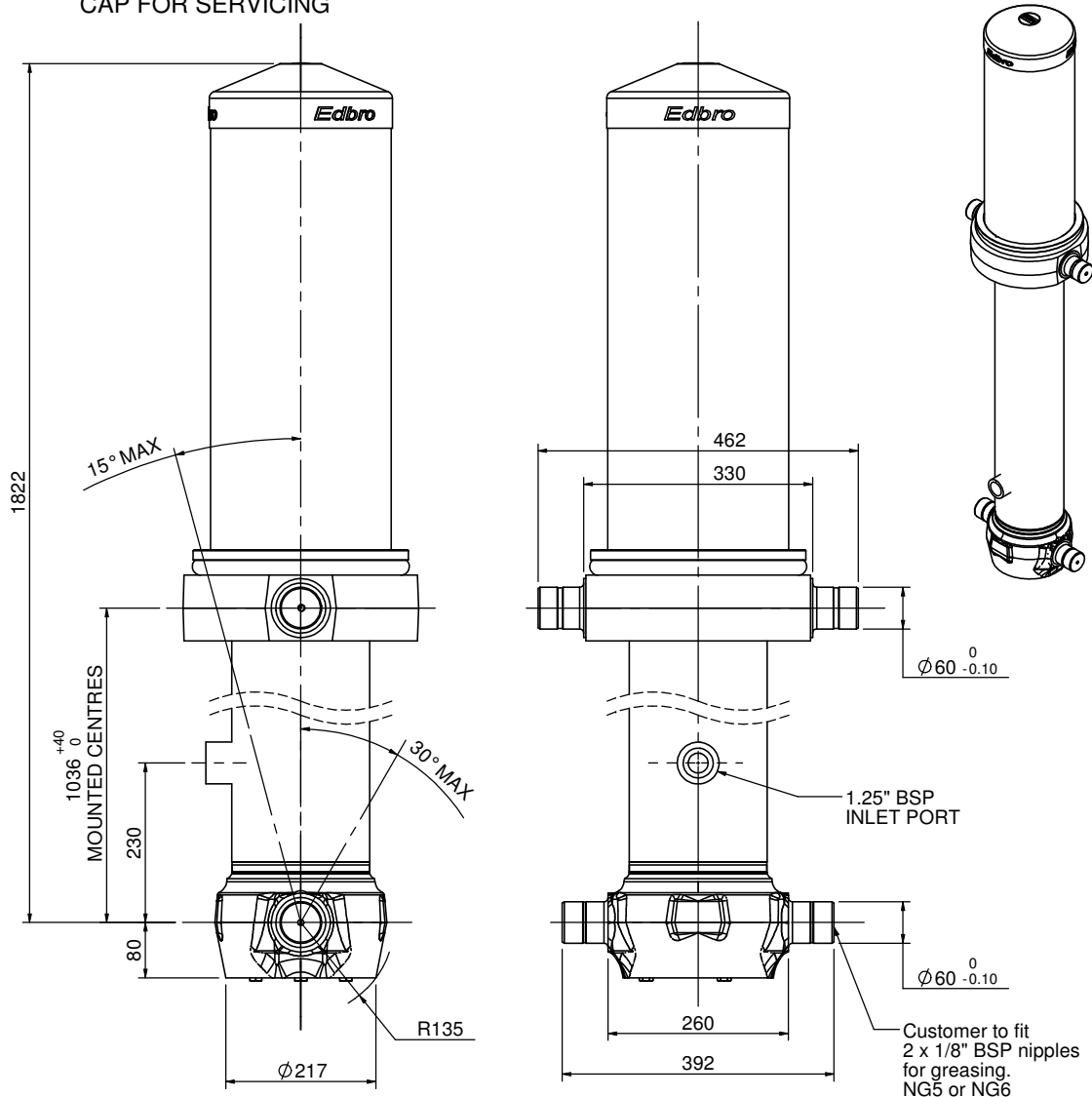

CS170057733B23A15

SPECIFICATION		RATED CAPACITY : 25-32 TONNES*		
Stage	Diameter	Length	Stroke	Swept Volume
OUTER COVER	260.35	750		
0	198.12	1775		
1	176.00	1740	1520	37.0
2	154.85	1740	1537	28.9
3	135.75	1740	1547	22.4
4	116.65	1740	1562	16.7
5	97.8	1740	1567	11.8
Final stroke reduced by	0	Total	7733	116.8
Cylinder Mass (Kg)	324	Priming Volume		12.0
Working Pressure (Bar)	120	Total Volume (Litres)		128.8
Maximum Pressure (Bar)	175	Max. first stage thrust		260 KN

*TIPPING CAPACITY AT WORKING PRESSURE

$\delta = 229$; $r = 900$

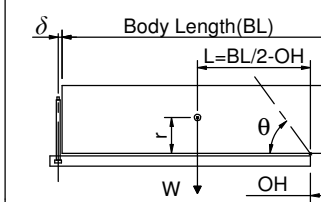

BODY LENGTH (BL)						OH
9500		10000		10500		
27	48°	26	46°	25	43°	150
29	50°	28	47°	26	45°	450
32	52°	30	49°	28	46°	750

For guidance only;

Higher working pressures may be possible. To check your application, email Edbro plc at <applications@edbro.co.uk>

NOTES

- If hydraulic pressure is used to limit overloading, the system relief valve must be set to the Working Pressure unless agreed by Edbro.
- The system relief valve can be set to Maximum Pressure if the load is limited by other means.
- This cylinder is for lifting purposes only and sload conditions must be avoided.
- Cylinder is painted in primer paint to RAL5010.
- See bracket options page 17BRKT01.
- See installation instructions INSTALL01.
- Use oil according to specification OIL01.

This drawing is available on request in PDF (2D), DXF (2D) or Parasolid (3D) via applications@edbro.co.uk

Edbro
SETTING THE INDUSTRY STANDARD

Edbro plc
Nelson Street, Bolton, Lancashire BL3 2JJ UK
Tel +44 (0) 1204 528888 Fax +44 (0) 1204 531957
Email: postmaster@edbro.com Web: www.edbro.com

Technical Specifications are subject to change without notice
Date Created/Updated: 09 April 2009 10:52:08
Refer www.edbro.com to confirm latest specification
All dimensions are in 'mm', unless otherwise stated