

Cylinder 5 stage front end with plain eye

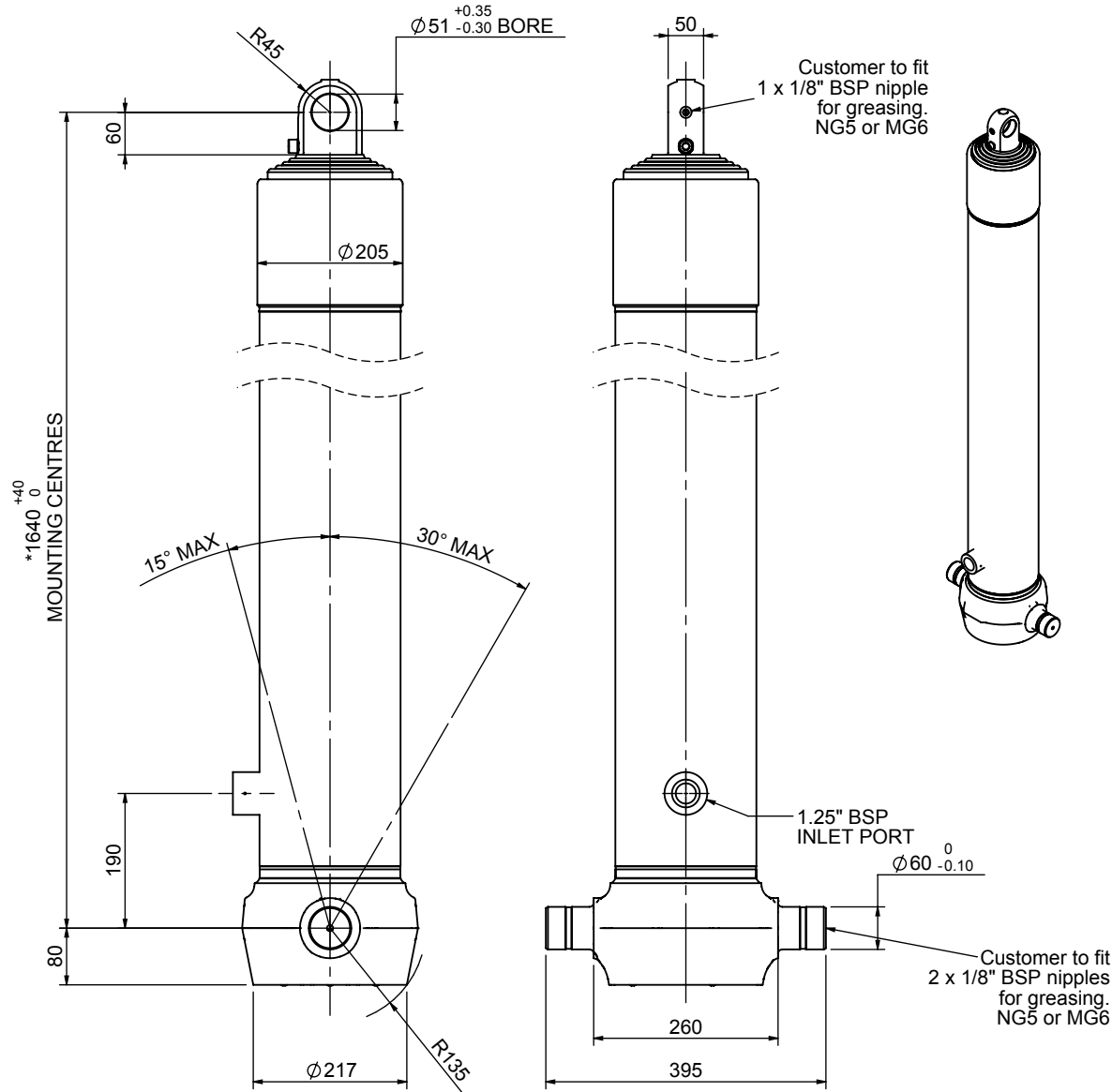

*Includes 9mm Pull Out.
Last Stage Chrome Plated

CS170E56983B19A01

SPECIFICATION		TIPPING CAPACITY : 23-31 TONNES***		
Stage	Diameter	Length	Stroke	Swept Volume
-	-	-	-	-
0	199	1625	-	-
1	176	1590	1367	33
2	155	1590	1387	26
3	136	1590	1397	20
4	117	1590	1412	15
5	98	1590	1417	11
Total (+5/-10)			6980	105
Final stroke reduced by	0	Priming Volume		22
Cylinder Mass (Kg)	238	Total Volume (Litres)		127
Maximum Pressure (Bar)	190	Max. first stage thrust		265 KN

***TIPPING CAPACITY AT WORKING PRESSURE

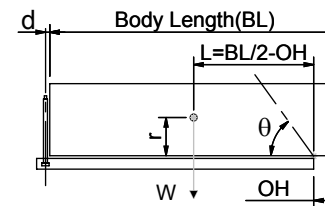

BODY LENGTH (BL)						OH
8500		9000		9500		
25	50°	24	47°	23	45°	150
28	53°	26	49°	25	46°	450
31	55°	28	51°	27	48°	750

d = 0; r = 900; Working Pressure 110 bar

For guidance only;

Higher working pressures and tipping capacities may be possible.

To check your application email - applications@edbro.co.uk

NOTES

1. This cylinder is for lifting purposes only and side load conditions should be avoided
2. Cylinder is painted in primer paint to RAL5013
3. Refer to www.edbro.com for:-
 - Bracket details
 - Installation instructions that must be observed
 - Correct oil selection
 - An explanation of tipping capacity

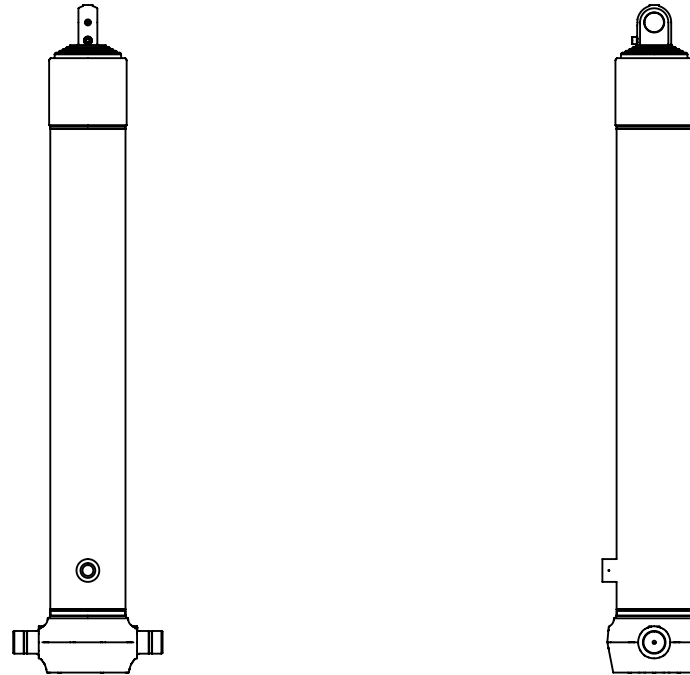

CS170E56983B19A01