

Cylinder 4 stage front end with spherical eye

CS180S46366B19A01

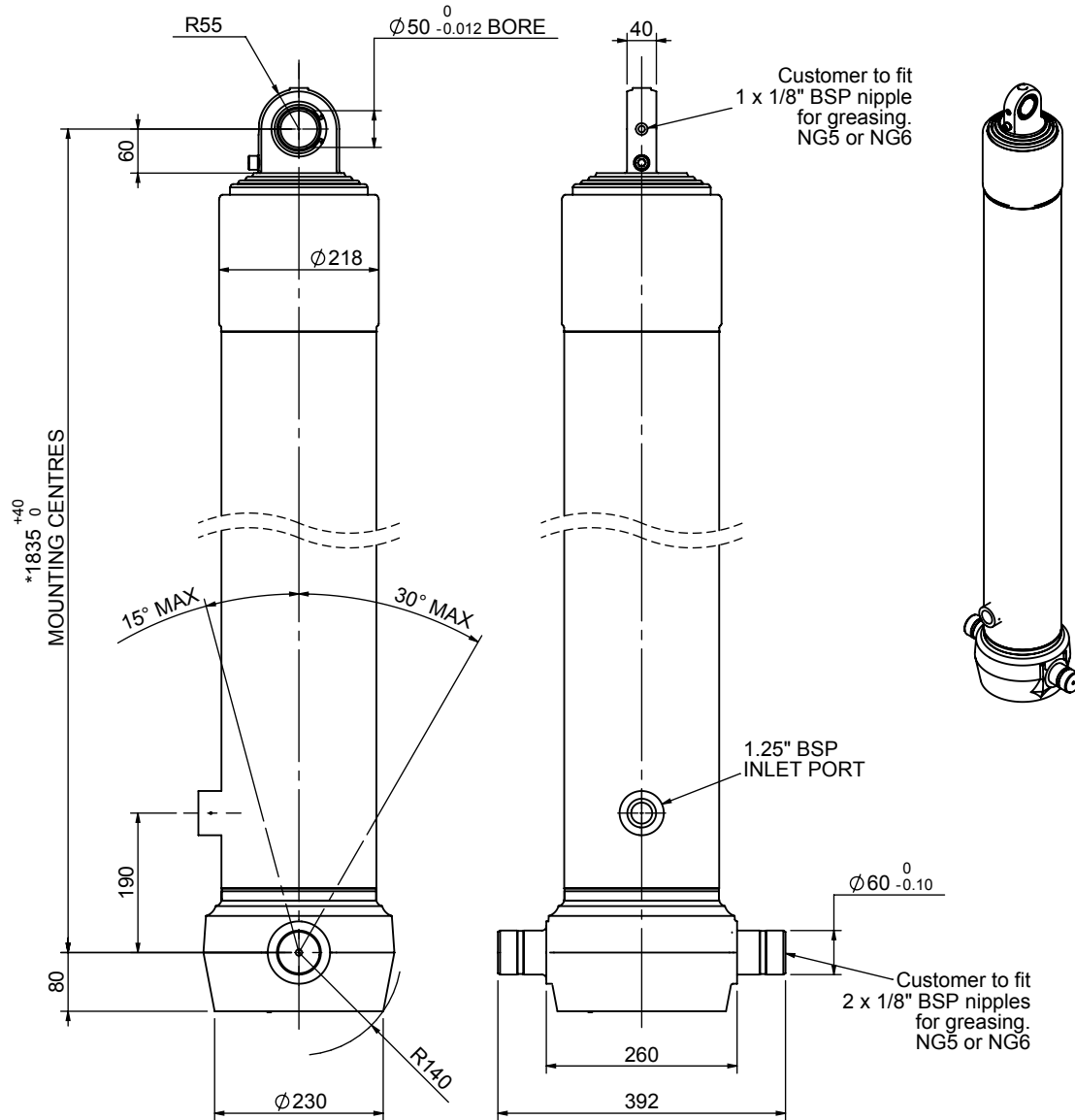

SPECIFICATION		TIPPING CAPACITY : 44-55 TONNES***		
Stage	Diameter	Length	Stroke	Swept Volume
-	-	-	-	-
-	-	-	-	-
0	211	1825	-	-
1	188	1790	1568	44
2	167	1790	1587	35
3	147	1790	1597	27
4	127	1790	1612	20
Total (+5/-10)			6364	126
Final stroke reduced by	0	Priming Volume		30
Cylinder Mass (Kg)	282	Total Volume (Litres)		156
Maximum Pressure (Bar)	190	Max. first stage thrust		265 KN

***TIPPING CAPACITY AT WORKING PRESSURE

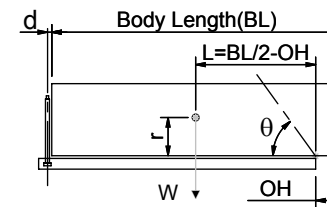

BODY LENGTH (BL)						OH
8250	8750	9250				
47	47°	45	44°	44	42°	150
51	49°	48	46°	46	43°	450
55	51°	52	48°	50	45°	750

d = 0; r = 750; Working Pressure 135 bar

For guidance only;

Higher working pressures and tipping capacities may be possible.

To check your application email - applications@edbro.co.uk

NOTES

1. This cylinder is for lifting purposes only and side load conditions should be avoided
2. Cylinder is painted in primer paint to RAL5013
3. Refer to www.edbro.com for:-
 - Bracket details
 - Installation instructions that must be observed
 - Correct oil selection
 - An explanation of tipping capacity

*Includes 9mm Pull Out.
Last Stage Chrome Plated



Edbro plc
Nelson Street, Bolton, England, BL3 2JJ
Tel +44 (0) 1204 528888 Fax +44 (0) 1204 531957
Email: postmaster@edbro.com Web: www.edbro.com

Technical Specifications are subject to change without notice
Date Created/Updated: 24 August 2012
Refer www.edbro.com to confirm latest specification
All dimensions are in 'mm', unless otherwise stated

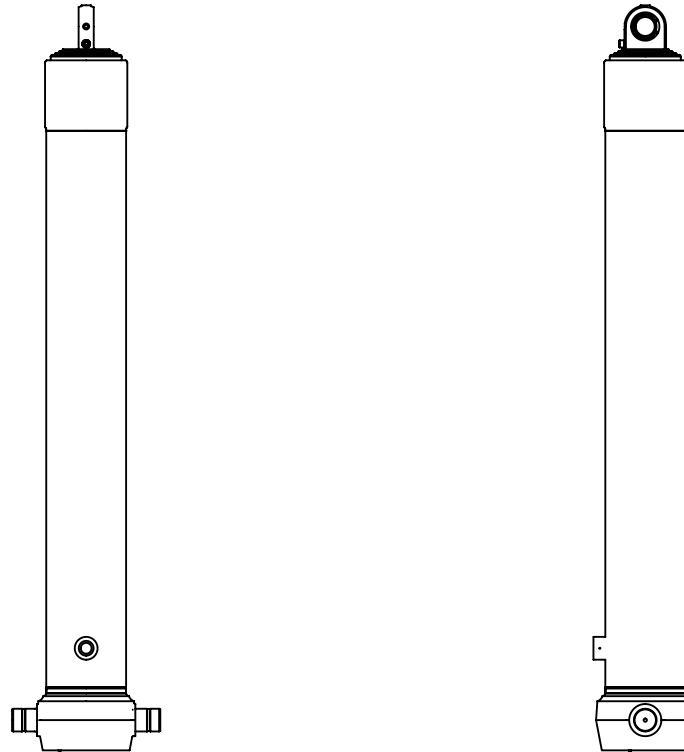

CS180S46366B19A01