

Cylinder 5 stage front end with spherical eye

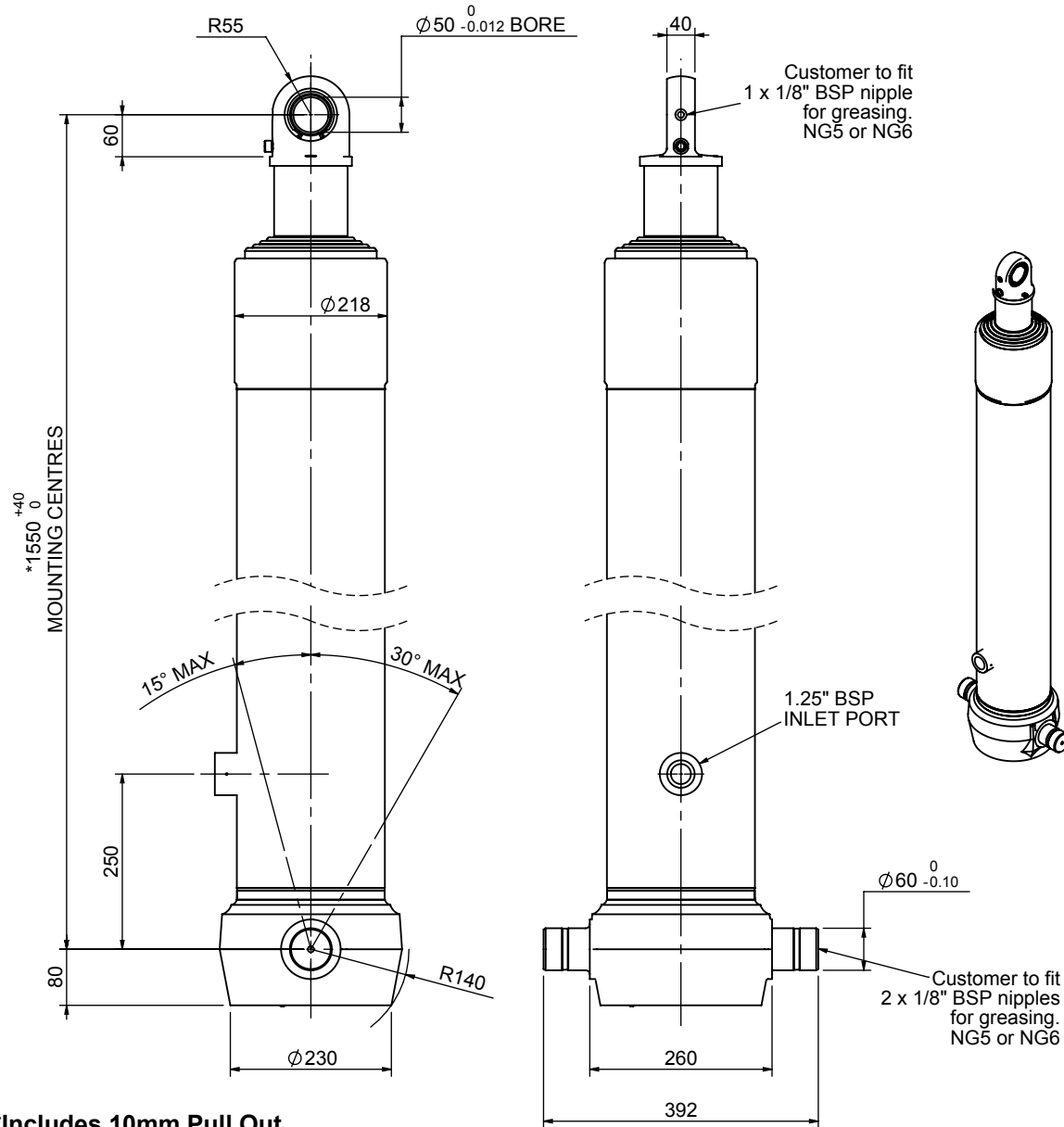

*Includes 10mm Pull Out.
Last Stage Chrome Plated

CS180S55983B25A05

SPECIFICATION		TIPPING CAPACITY : 41-56 TONNES***		
Stage	Diameter	Length	Stroke	Swept Volume
-	-	-	-	-
0	211	1425	-	-
1	188	1390	1167	32
2	167	1390	1187	26
3	147	1390	1197	20
4	127	1390	1212	15
5	105	1490	1217	11
Total (+5/-10)			5980	104
Final stroke reduced by	0	Priming Volume		21
Cylinder Mass (Kg)	257	Total Volume (Litres)		125
Maximum Pressure (Bar)	190	Max. first stage thrust		265 KN

***TIPPING CAPACITY AT WORKING PRESSURE

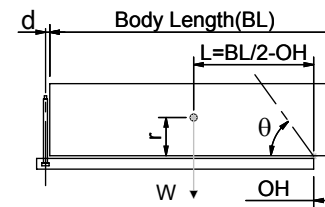

BODY LENGTH (BL)					OH	
7500	8000	8500				
45	49°	43	46°	41	43°	150
50	51°	46	48°	44	44°	450
56	54°	51	50°	48	46°	750

d = 0; r = 750; Working Pressure 175 bar

For guidance only;

Higher working pressures and tipping capacities may be possible.

To check your application email - applications@edbro.co.uk

NOTES

1. This cylinder is for lifting purposes only and side load conditions should be avoided
2. Cylinder is painted in primer paint to RAL5013
3. Refer to www.edbro.com for:-
 - Bracket details
 - Installation instructions that must be observed
 - Correct oil selection
 - An explanation of tipping capacity

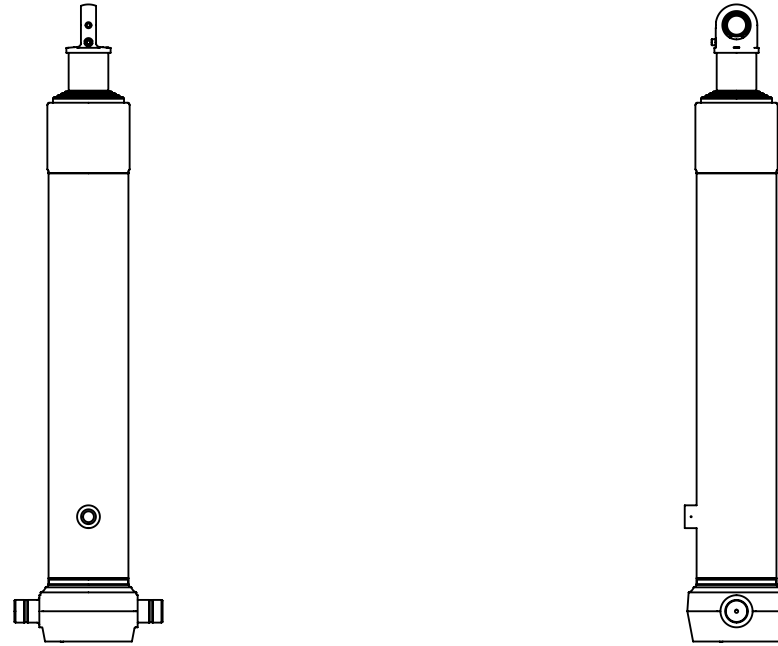

CS180S55983B25A05